

Indications for Use

The Zfx™ Torque Handpiece is used to mount various screwdriver tips for dental laboratory purposes such as screw and unscrew prosthetic parts and scanbodies. The tool is not intended to be used in a patient's mouth.

Device description

The Zfx™ Torque Handpiece is designed with an ISO-latch connection. All screwdriver tips with a corresponding ISO-latch feature can be used with the Zfx™ Torque Handpiece. The tool is equipped with an adjusting knob which allows to regulate the torque value approximately from 2Ncm to 8Ncm.

The torque feature works exclusively while tightening, not while the opening process of a screw.

The Zfx™ Torque Handpiece is an individually packaged reusable tool. It is designed exclusively for laboratory use. The tool is provided non-sterile and must be cleaned prior to use.

Materials

The Zfx™ Torque Handpiece is assembled from various components of the following materials:

- × Stainless steel EN 1.4125 (polished)
- × Carbon steel EN 10270.1
- × Aluminium EN 7075-T651 (anodized)
- × Plastic Polyslider® (nylon material)

Procedure

× Handling

1. Regulating Cap
2. Handle Piece
3. Rectangular Button
4. Head Piece
5. Screwdriver with ISO-latch (not included)

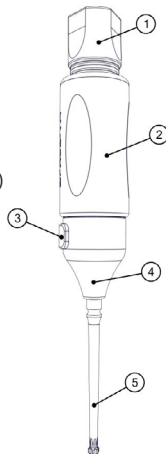

Step 1: Push the rectangular button on the head piece of the tool.

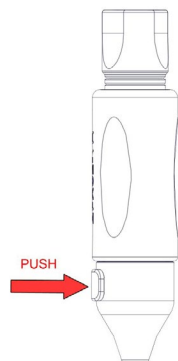

Step 2: Insert the ISO-latch shaft of a corresponding screwdriver tip in the hole at the Head Piece of the tool.



Step 3: Rotate the screwdriver tip with the button still pushed until the screwdriver tip locks into place. Release the Rectangular Button and check if the screwdriver tip stays secured.

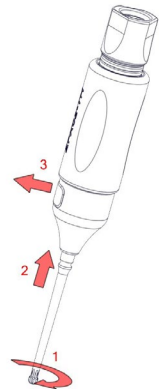

Step 4: Adjust the desired torque value by rotating the red Regulating Cap to the right (increase of torque value) or to the left (decrease of torque value). The torque range is approximately from 2Ncm to 8Ncm.

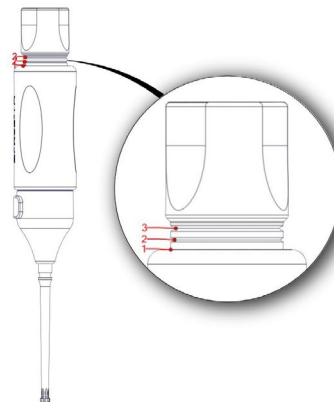
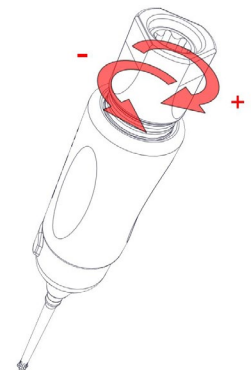

The Regulating Cap has three grooves to roughly indicate the set torque value. When aligned with the edge of the blue Handle Piece groove 1 indicates approximately 2Ncm, groove 2 indicates approximately 4Ncm and groove 3 indicates approximately 8Ncm.



Note: To disable the torque function, rotate the Regulating Cap to the right until it jams with the blue Handle Piece.

Step 5: Engage the screwdriver tip with the corresponding feature on the screwhead.

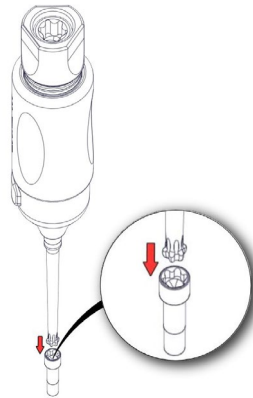

Step 6: Screw in the screw by turning the Zfx™ Torque Handpiece to the right. The preset torque is reached as soon as an overleaping of the handle piece is perceptible.

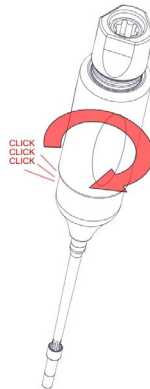

× Cleaning

The Zfx™ Torque Handpiece should only be cleaned with a damp cloth.

Storage and Handling

The Zfx™ Torque Handpiece should be stored in cleaned conditions in a dry place at room temperature.

Contraindications

None

Known Side Effects

None



Warnings

- × The Zfx™ Torque Handpiece must only be used and handled by dental professionals who have approved training in dentistry.
- × The setting of the torque value (refer to Step 4) is not specified to be exact, it is an approximately setting and the values are not guaranteed. Furthermore please be aware not to over-torque the driver tip in case of blocking the torque function! Please refer and follow to driver's specifications!
- × The Zfx™ Torque Handpiece must only be used with Screwdriver tips with ISO-latch connection to avoid damage of the mechanism.
- × Do not use additional tools in combination with the Zfx™ Torque Handpiece.
- × The abusive use of the Zfx™ Torque Handpiece may damage the tool and/or injure the user.
- × Wrong storage of the Zfx™ Torque Handpiece may lead to malfunction or damage.
- × The Zfx™ Torque Handpiece is composed of conductive materials. The tool offers no protection against electricity!

Explanation of symbols



Product is packaged 'non sterile'



Unique Device Identifier



Manufacturer Information: Address of legal manufacturer facility



Quantity / Unit of package content



LOT-Number, Symbol followed by Production Date of the lot.



Reference Number, Symbol followed by Manufacturer's Item Number



Refer to Instruction for use:
<https://dentaltec.zfx-dental.com/en/downloads>

Information on Manufacturer

Zfx GmbH
 Kopernikusstraße 15
 85221 Dachau
 Germany

T +49 (0) 8131/33 244 - 0
 F +49 (0) 8131/33 244 - 10
www.zfx-dental.com

Incident Reporting / Complaints:

Please send to qm@zfx-dental.com